

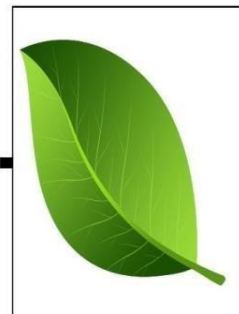

❖ Trace the sleeping line with blue colour.

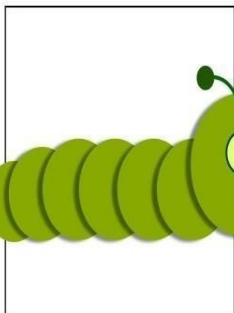

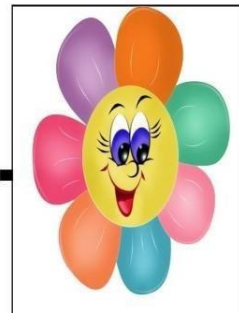
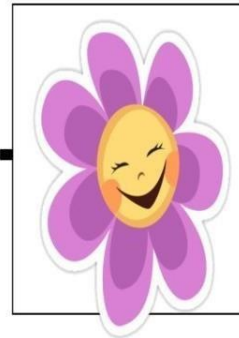
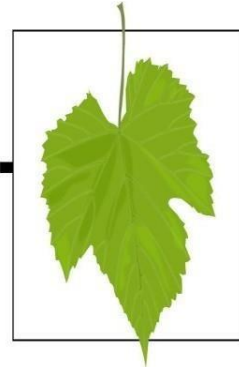
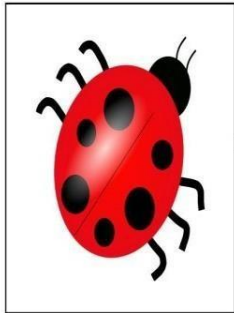

Draw a line with crayon each picture to correct letter .

h

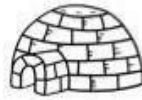

g

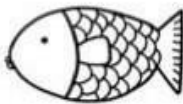

i



j

f





S.K.PATEL KINDERGARTEN ENGLISH MEDIUM SCHOOL, GANDHINAGAR

Name: _____

Roll No. : _____

NURSERY

Worksheet :JULY 2022

Subject : MATHS

Date :

❖ **Colour only one lollipop with the help of cotton .**

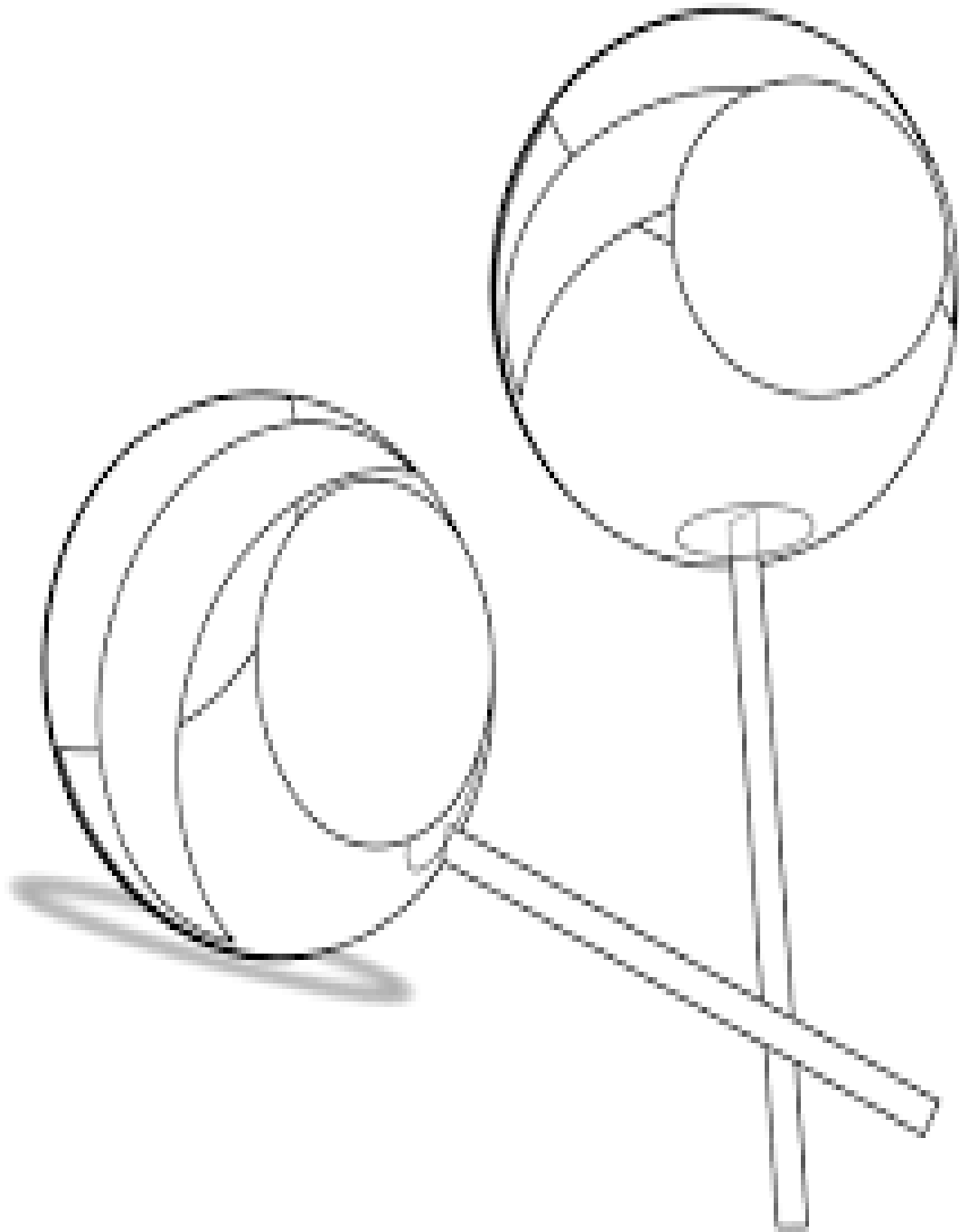



Name: _____

Roll No. : _____

NURSERY

Worksheet :JULY 2022

Subject : MATHS

Date :

❖ **Stick the stars on the number one.**

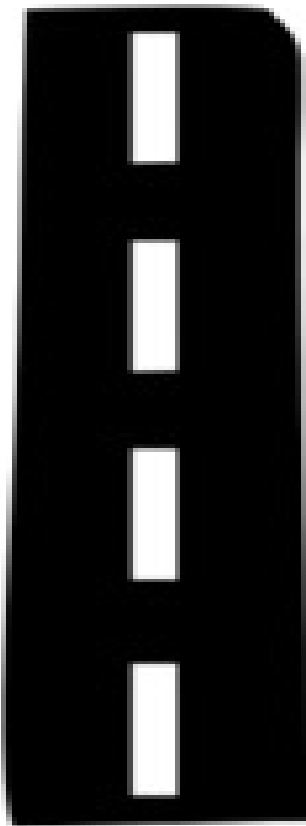

ONE



Name: _____

Roll No. : _____

NURSERY

Worksheet : JULY 2022

Subject : E.V.S

Date :



Colour the spinach.

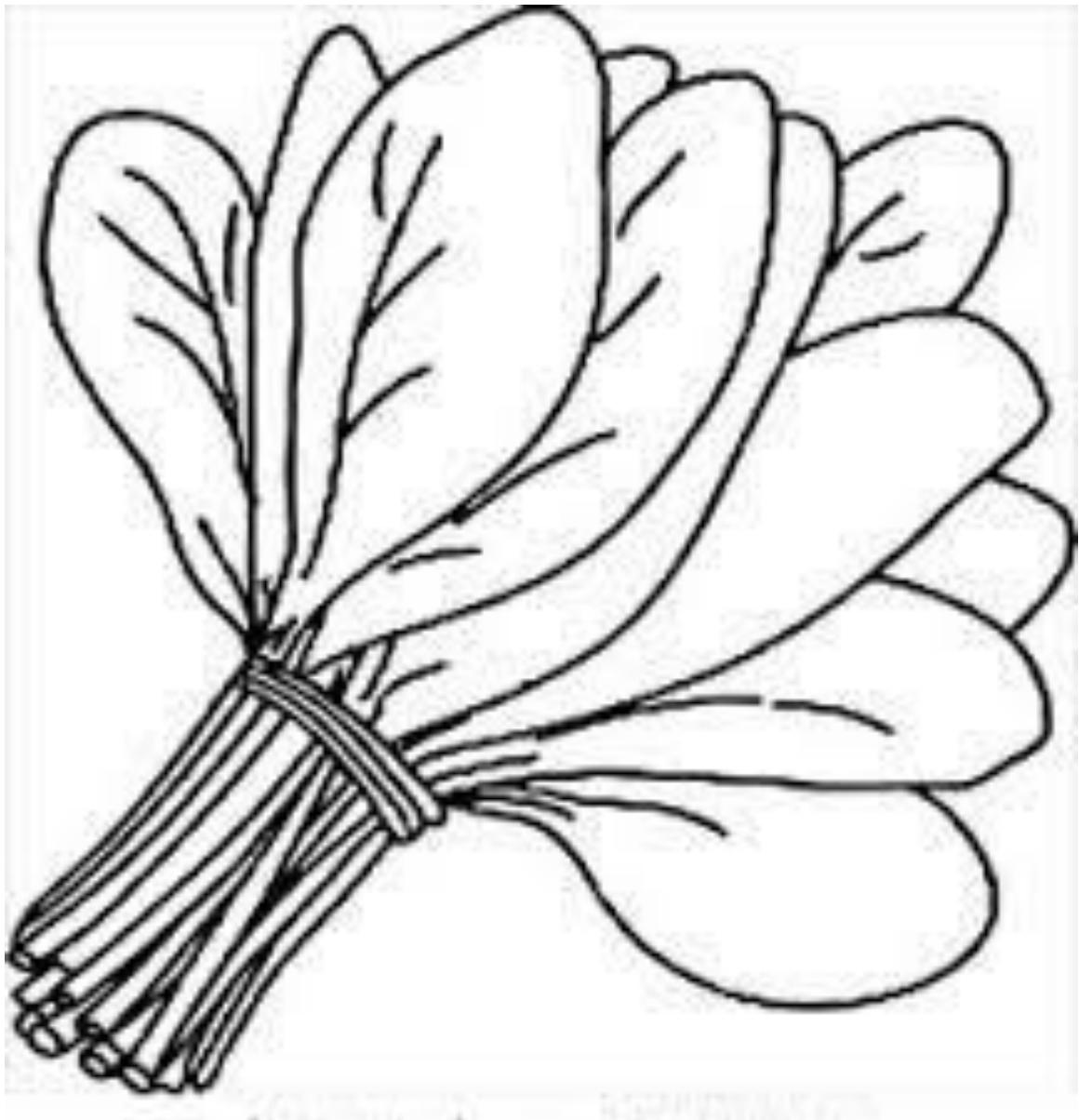



S.K.PATEL KINDERGARTEN ENGLISH MEDIUM SCHOOL, GANDHINAGAR

Name: _____

Roll No. : _____

NURSERY

Worksheet : JULY 2022

Subject : E.V.S

Date :





Colour it.

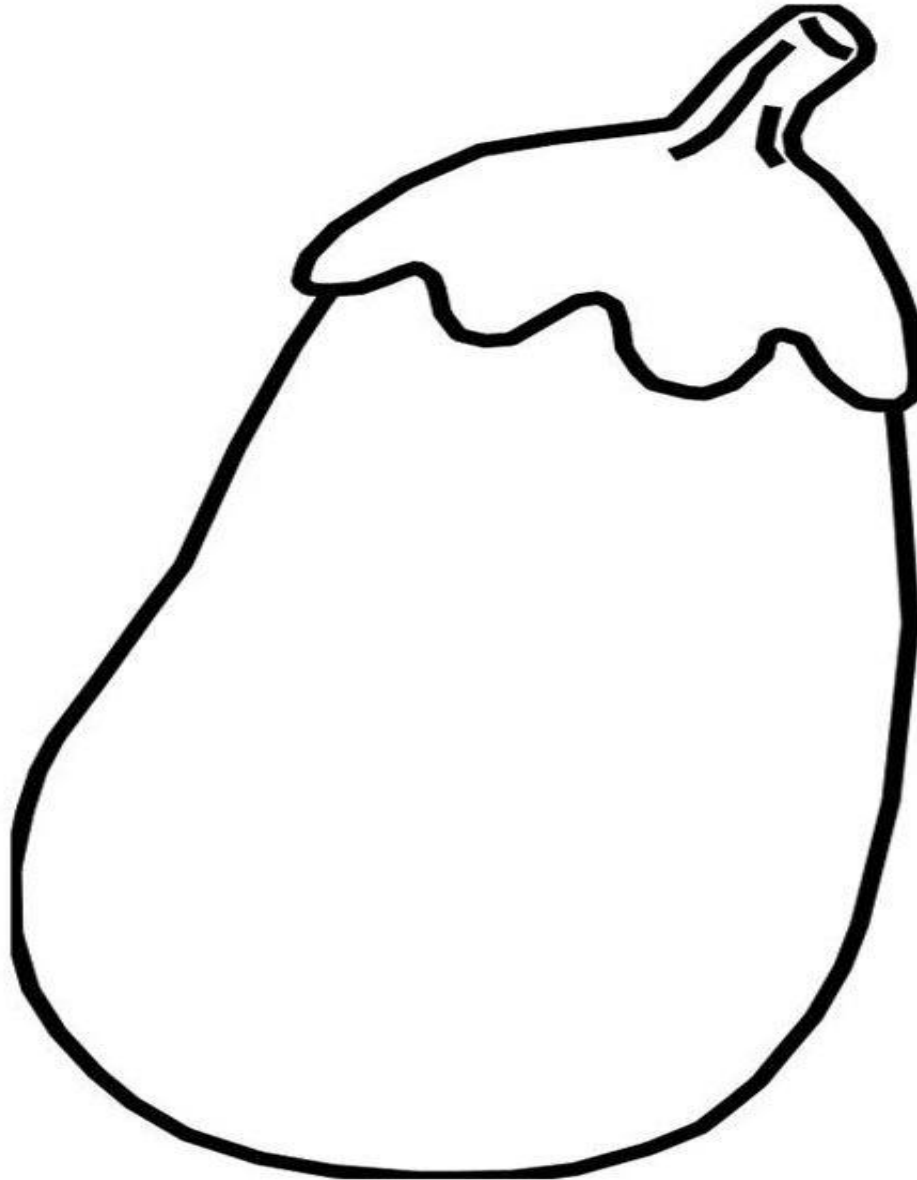



S.K.PATEL KINDERGARTEN ENGLISH MEDIUM SCHOOL, GANDHINAGAR

Name: _____

Roll No. : _____

NURSERY

Worksheet : JULY 2022

Subject : DRAWING

Date :

❖ Colour the ball.

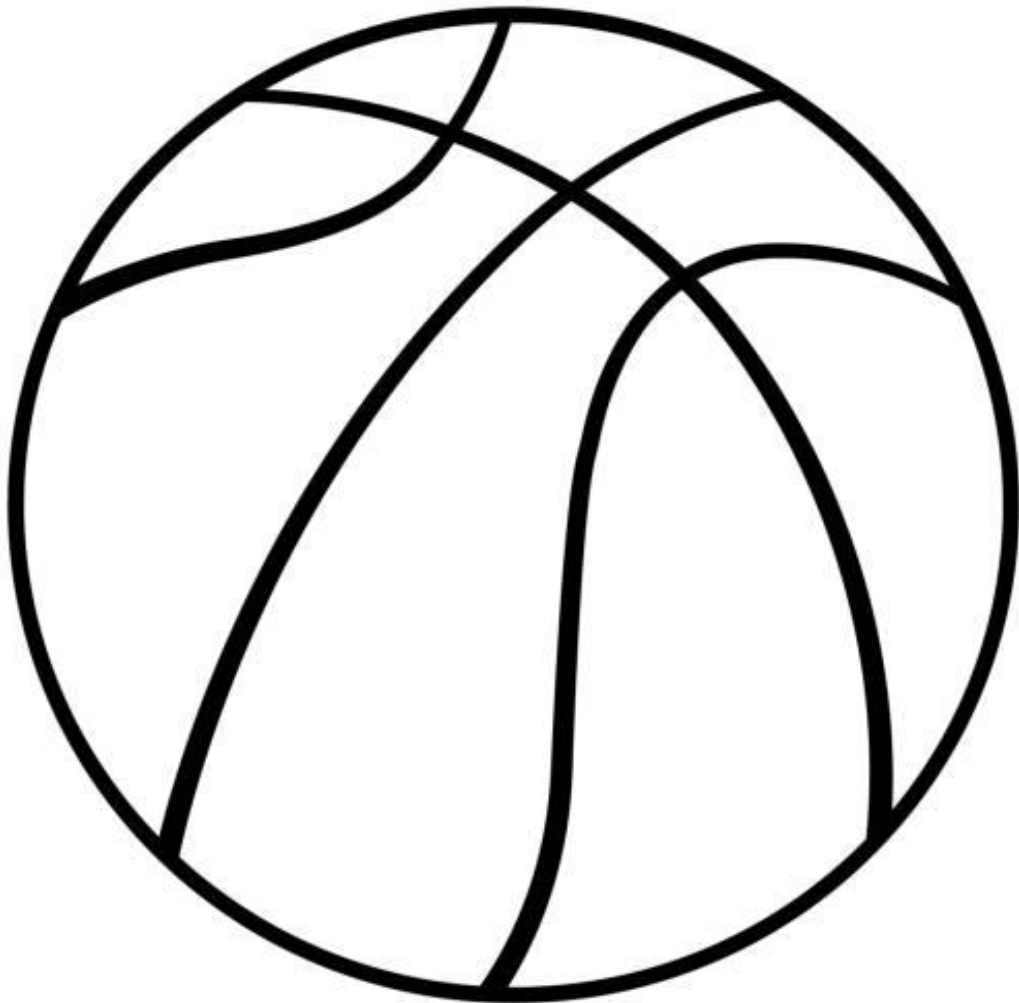



S.K.PATEL KINDERGARTEN ENGLISH MEDIUM SCHOOL, GANDHINAGAR

Name: _____

Roll No. : _____

NURSERY

Worksheet : JULY 2022

Subject : CRAFT

Date :



Make the sun with matchsticks and colour it.

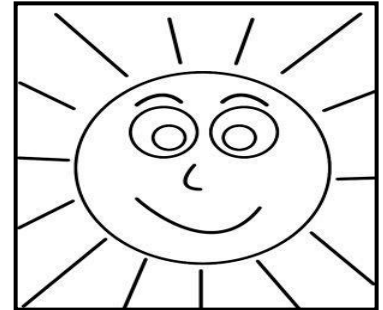



S.K.PATEL KINDERGARTEN ENGLISH MEDIUM SCHOOL, GANDHINAGAR

Name: _____

Roll No. : _____

NURSERY

Worksheet : JULY 2022

Subject : CRAFT

Date :

❖ **Make palm printing**